



Getting Started with HFSS: TDR for Coax Bend



ANSYS, Inc.
Southpointe
2600 Ansys Drive
Canonsburg, PA 15317
ansysinfo@ansys.com
<https://www.ansys.com>
(T) 724-746-3304
(F) 724-514-9494

Release 2024 R2
July 2024

ANSYS, Inc. and ANSYS
Europe, Ltd. are UL registered
ISO 9001:2015 companies.

Copyright and Trademark Information

© 1986-2024 ANSYS, Inc. Unauthorized use, distribution or duplication is prohibited.

ANSYS, Ansys Workbench, AUTODYN, CFX, FLUENT and any and all ANSYS, Inc. brand, product, service and feature names, logos and slogans are registered trademarks or trademarks of ANSYS, Inc. or its subsidiaries located in the United States or other countries. ICM CFD is a trademark used by ANSYS, Inc. under license. All other brand, product, service and feature names or trademarks are the property of their respective owners. FLEXIm and FLEXnet are trademarks of Flexera Software LLC.

Disclaimer Notice

THIS ANSYS SOFTWARE PRODUCT AND PROGRAM DOCUMENTATION INCLUDE TRADE SECRETS AND ARE CONFIDENTIAL AND PROPRIETARY PRODUCTS OF ANSYS, INC., ITS SUBSIDIARIES, OR LICENSORS. The software products and documentation are furnished by ANSYS, Inc., its subsidiaries, or affiliates under a software license agreement that contains provisions concerning non-disclosure, copying, length and nature of use, compliance with exporting laws, warranties, disclaimers, limitations of liability, and remedies, and other provisions. The software products and documentation may be used, disclosed, transferred, or copied only in accordance with the terms and conditions of that software license agreement.

ANSYS, Inc. and ANSYS Europe, Ltd. are UL registered ISO 9001: 2015 companies.

U.S. Government Rights

For U.S. Government users, except as specifically granted by the ANSYS, Inc. software license agreement, the use, duplication, or disclosure by the United States Government is subject to restrictions stated in the ANSYS, Inc. software license agreement and FAR 12.212 (for non-DOD licenses).

Third-Party Software

See the legal information in the product help files for the complete Legal Notice for Ansys proprietary software and third-party software. If you are unable to access the Legal Notice, please contact ANSYS, Inc.

Conventions Used in this Guide

Please take a moment to review how instructions and other useful information are presented in this documentation.

- Procedures are presented as numbered lists. A single bullet indicates that the procedure has only one step.
- Bold type is used for the following:
 - Keyboard entries that should be typed in their entirety exactly as shown. For example, “**copy file1**” means you must type the word **copy**, then type a space, and then type **file1**.
 - On-screen prompts and messages, names of options and text boxes, and menu commands. Menu commands are often separated by greater than signs (>). For example, “click **HFSS > Excitations > Assign > Wave Port.**”
 - Labeled keys on the computer keyboard. For example, “Press **Enter**” means to press the key labeled **Enter**.
- Italic type is used for the following:
 - Emphasis.
 - The titles of publications.
 - Keyboard entries when a name or a variable must be typed in place of the words in italics. For example, “**copy filename**” means you must type the word **copy**, then type a space, and then type the name of the file.
- The plus sign (+) is used between keyboard keys to indicate that you should press the keys at the same time. For example, “Press Shift+F1” means to press the **Shift** key and, while holding it down, press the **F1** key also. You should always depress the modifier key or keys first (for example, Shift, Ctrl, Alt, or Ctrl+Shift), continue to hold it/them down, and then press the last key in the instruction.

Accessing Commands: *Ribbons*, *menu bars*, and *shortcut menus* are three methods that can be used to see what commands are available in the application.

- The *Ribbon* occupies the rectangular area at the top of the application window and contains multiple tabs. Each tab has relevant commands that are organized, grouped, and labeled. An example of a typical user interaction is as follows:

"Click **Draw > Line**"



This instruction means that you should click the **Line** command on the **Draw** ribbon tab. An image of the command icon, or a partial view of the ribbon, is often included with the instruction.

- The *menu bar* (located above the ribbon) is a group of the main commands of an application arranged by category such File, Edit, View, Project, etc. An example of a typical user interaction is as follows:

"On the **File** menu, click the **Open Examples** command" means you can click the **File** menu and then click **Open Examples** to launch the dialog box.

- Another alternative is to use the *shortcut menu* that appears when you click the right-mouse button. An example of a typical user interaction is as follows:

"Right-click and select **Assign Excitation > Wave Port**" means when you click the right-mouse button with an object face selected, you can execute the excitation commands from the shortcut menu (and the corresponding sub-menus).

Getting Help: Ansys Technical Support

For information about Ansys Technical Support, go to the Ansys corporate Support website, <http://www.ansys.com/Support>. You can also contact your Ansys account manager in order to obtain this information.

All Ansys software files are ASCII text and can be sent conveniently by e-mail. When reporting difficulties, it is extremely helpful to include very specific information about what steps were taken or what stages the simulation reached, including software files as applicable. This allows more rapid and effective debugging.

Help Menu

To access help from the Help menu, click **Help** and select from the menu:

- **[product name] Help** - opens the contents of the help. This help includes the help for the product and its *Getting Started Guides*.
- **[product name] Scripting Help** - opens the contents of the *Scripting Guide*.
- **[product name] Getting Started Guides** - opens a topic that contains links to Getting Started Guides in the help system.

Context-Sensitive Help

To access help from the user interface, press **F1**. The help specific to the active product (design type) opens.

You can press **F1** while the cursor is pointing at a menu command or while a particular dialog box or dialog box tab is open. In this case, the help page associated with the command or open dialog box is displayed automatically.

Table of Contents

Table of Contents	Contents-1
1 - Introduction	1-1
Model Geometry	1-1
2 - Coax Bend Model	2-1
Enable Legacy View Orientations	2-1
Create Bottom Leg	2-3
Design Variables to Control Bend	2-4
Create Relative Coordinate System	2-5
Copy and Rotate Bottom Leg	2-6
Create Bend	2-8
Unite Objects	2-10
Enable Material Overrides	2-12
Create Air Object Cross Section	2-13
Excitations	2-14
Solution Setup	2-16
3 - Simulation and Results	3-1
TDR Impedance Plot	3-1
Interpretation of TDR Impedance Plot	3-3
S-Parameter vs. Frequency Plot	3-6
E-Field Overlay	3-8
Parametric Sweep	3-12
4 - Optionally, Restore Current View Orientations	4-1

1 - Introduction

This Getting Started Guide is based on an HFSS Transient analysis of a coax cable. Specifically, you will create a parameterized model of a bend in a coax cable and perform a time-domain reflectometry (TDR) analysis. Using the techniques detailed herein, you will observe disturbances in the characteristic impedance of the coax bend as the signal propagates through the model and passes geometrical discontinuities.

Note:

This Getting Started Guide differs from others in that it assumes you already have a working knowledge of basic model construction, ribbon / menu navigation, and so forth. You are given the parameters of objects to build, excitations to apply, and setups to define. However, the step-by-step command and entry procedures are *not* included for commonly performed and unambiguous tasks. As such, this guide is more appropriate for intermediate to advanced users of the Ansys Electronics Desktop application, or at least beginners who have completed a couple of other Getting Started Guides and are comfortable with the user interface. If you would like to first complete a coax example that includes explicit step-by-step instructions, please see one of the following exercises:

- HFSS Getting Started Guides:
 - HFSS Coax Tee (relatively simple model)
 - HFSS Coax Connector (more complex model)

Model Geometry

The model geometry is shown in the following figure. It consists of two straight sections and a bend between them. The region between the inner and outer conductors is mostly filled with air (transparent blue object). The inner conductor (red object) is held in place by two Teflon slugs (green cylindrical objects). At the slugs, the radius of the inner conductor has been adjusted to keep the characteristic impedance close to 50 ohms. The air body is sectioned to form a sheet object along the XZ plane as a target for overlaying field results.

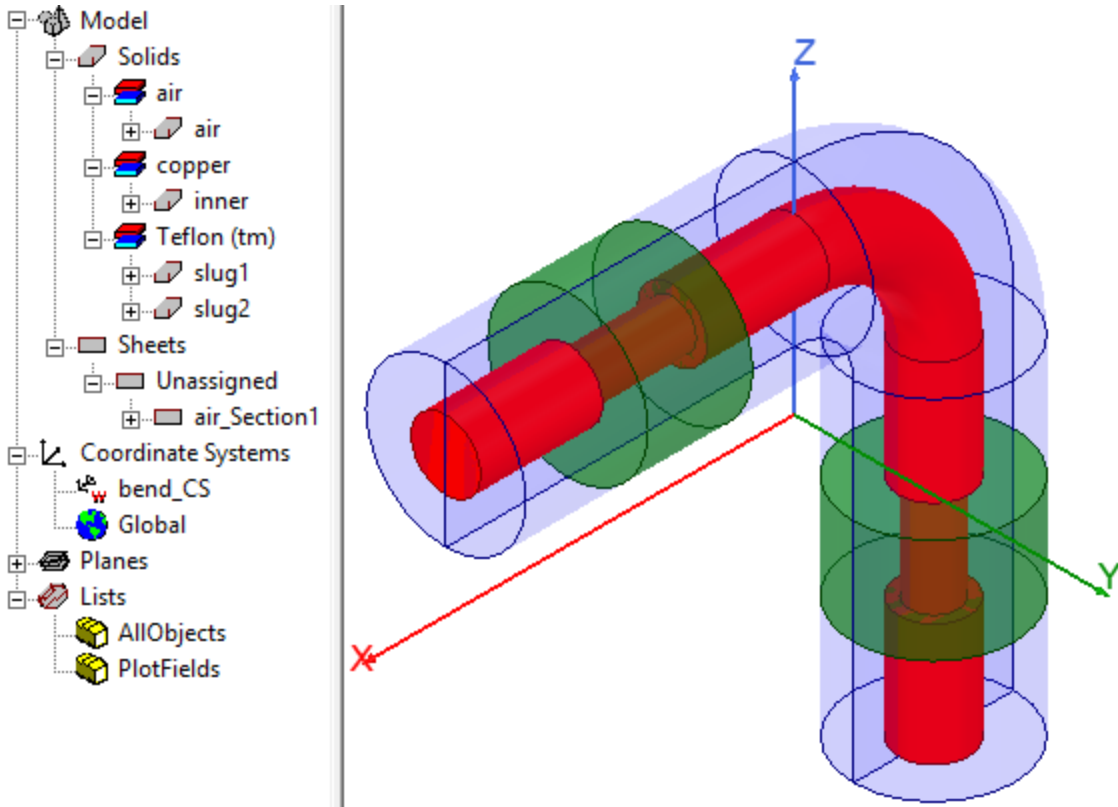

Figure 1-1: Coax with Bend – Model Geometry

2 - Coax Bend Model

The topics in this chapter cover drawing the model geometry, specifying design variables to control the bend parametrically, creating a relative coordinate system, assigning excitations, creating a face at the coax cross section for field plotting, and setting up the solution.

1. Begin by launching the *Ansys Electronics Desktop* application, inserting an **HFSS** design into a new project, and designating the *Solution Type* as a **Transient Network Analysis**.

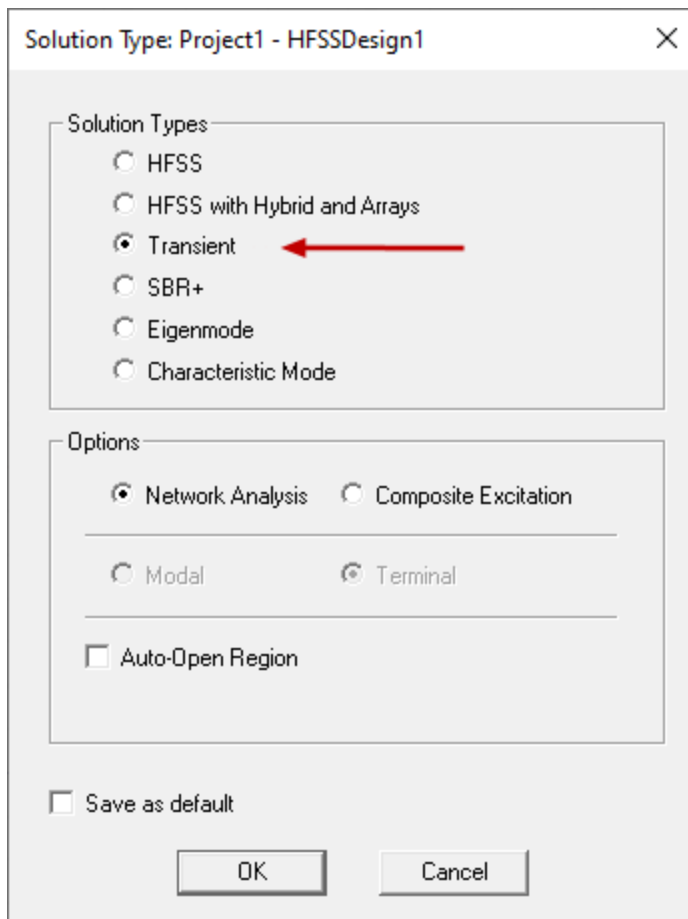

Figure 2-1: Solution Type Settings

2. Use  **Save As** to save the project, giving it the name **CoaxBend**.

Enable Legacy View Orientations

This getting started guide was created based on standard view orientations that were in effect for version 2023 R2 and earlier of the Ansys Electronics Desktop application. For consistency

between your experience and the views and instructions contained in this guide, select the *Enable Legacy View Orientation* option in the 3D UI Options dialog box, as follows:

1. From the menu bar, click **View > Options**.

The *3D UI Options* dialog box appears.

2. Select **Enable Legacy View Orientation**:

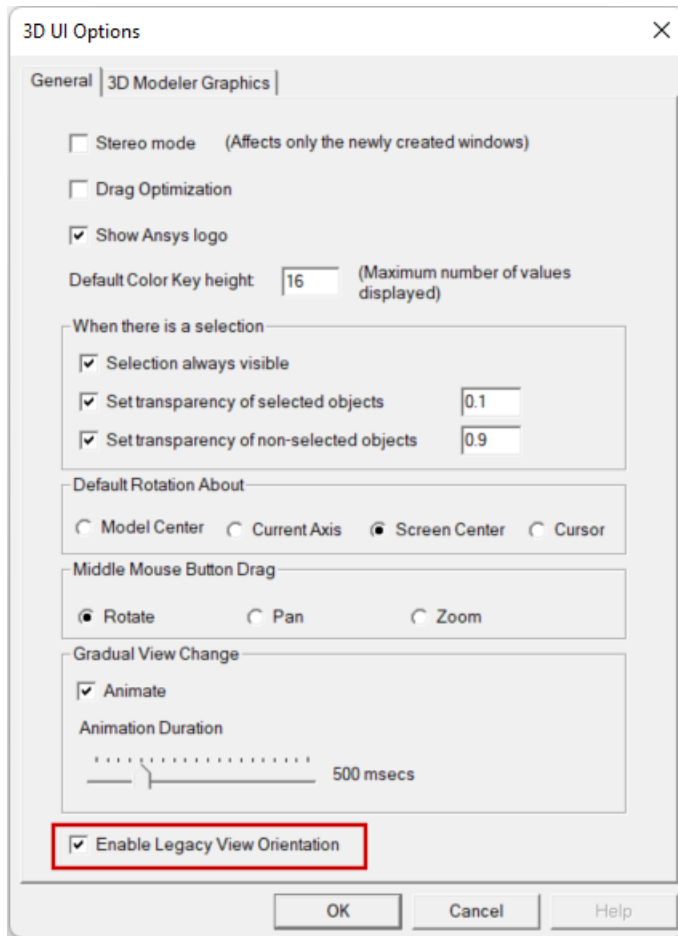

3. Click **OK**.

Changing the view orientation option does not change the model viewpoint that was in effect at the time.

4. On the **Draw** ribbon tab, click **Orient** to change to the *Trimetric* view, which is the default legacy view orientation.

You do not have to select *Trimetric* from the *Orient* drop-down menu. The default view appears when you click *Orient*.

Although this option can only be accessed once a design is added to a project, it is a global option. Your choice is retained for all future program sessions, projects, and design types that use the 3D Modeler or that produce 3D plots of results.

At the end of this guide, you will be prompted to clear the *Enable Legacy View Orientation* option, if you prefer to use the view orientation scheme implemented for 2024 R1 and newer versions going forward.

For a comparison of the legacy and current view orientations, search for "View Options: 3D UI Options" in the HFSS help. Additionally, views associated with **Alt + double-click** zones have been redefined. The current orientations are shown in the help topic, "Changing the Model View with Alt+Double-Click Areas."

Create Bottom Leg

You will first draw the bottom leg of the coax bend model. Draw all of these objects using the XY drawing plane. Later, you will copy and rotate these objects to create the leg at the opposite end of the coax bend.

1. Set the **Units** to **mm** (millimeters).
2. Using your preferred drawing mode (draw freehand and edit properties, use coordinate text boxes, or use dialog box entry mode), create the following objects:
 - a. *Bottom part of inner conductor:*
 - **Cylinder** with base **(0, 0, 0)**, **radius 1 mm**, and **height 3.5 mm**
 - **Material = copper**
 - **Name = inner**
 - **Color is red** with **Transparent = 0**
 - b. *Air:*
 - **Cylinder** with base **(0, 0, 0)**, **radius 2.3 mm**, and **height 10 mm**
 - **Material = air**
 - **Name = air**
 - **Color is blue** with **Transparent = 0.9**
 - c. *First slug:*
 - **Cylinder** with base **(0, 0, 3.5 mm)**, **radius 2.3 mm**, and **height 3 mm**
 - **Material = Teflon (tm)**
 - **Name = slug1**
 - **Color is dark green** with **Transparent = 0.6**
 - d. *Inner conductor in slug:*
 - **Cylinder** with base **(0, 0, 3.5 mm)**, **radius 0.6875 mm**, and **height 3 mm**
 - **Material = copper**

- *Name* = **inner2**
 - *Color* is **red** with *Transparent* = 0
- e. *Inner conductor above slug:*
- **Cylinder** with *base* (0, 0, 6.5 mm), *radius* 1 mm, and *height* 3.5 mm
 - *Material* = **copper**
 - *Name* = **inner3**
 - *Color* is **red** with *Transparent* = 0

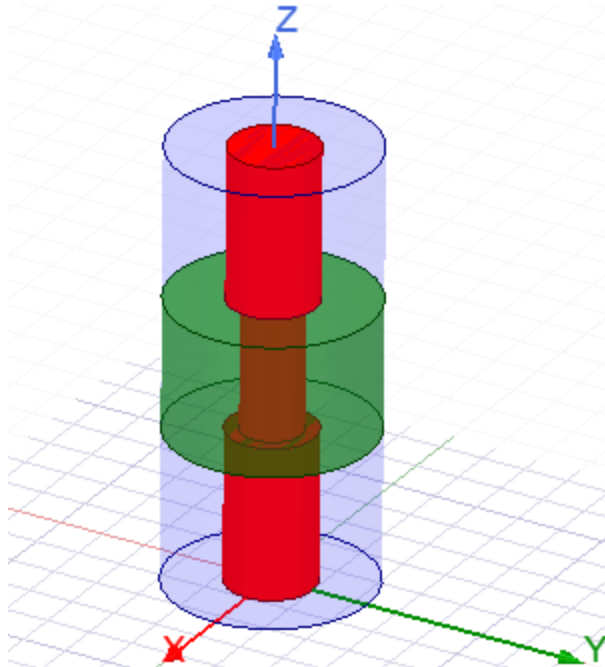

Figure 2-2: Bottom Leg of Model Drawn

3.  **Save** the project.

Design Variables to Control Bend

Create two design variables to control the bend angle and the bend radius parametrically.

1. Right-click on the design name in the Project Manager and select **Design Properties**.
2. Add two variables:
 - a. **bend_radius**, initial value **4 mm**
 - b. **bend_angle**, initial value **90 deg**

Local Variables									
<input checked="" type="radio"/> Value <input type="radio"/> Optimization / Design of Experiments <input type="radio"/> Tuning <input type="radio"/> Sensitivity <input type="radio"/> Statistics									
Name	Value	Unit	Evaluated Value	Type	Description	Read-only	Hidden	Sweep	
bend_radius	4	mm	4mm	Design		<input type="checkbox"/>	<input type="checkbox"/>	<input checked="" type="checkbox"/>	
bend_angle	90	deg	90deg	Design		<input type="checkbox"/>	<input type="checkbox"/>	<input checked="" type="checkbox"/>	

Figure 2-3: Design Variables to Parametrically Control the Bend

3. Click **OK** to close the *Properties* dialog box.

Create Relative Coordinate System

You will now create a relative coordinate system with an origin located at the center of the bend. The coordinate system origin will update parametrically as the bend radius changes.

1. On the **Draw** ribbon tab, click  **Relative CS** (*Offset Origin*).

Note:

You do not have to access the *Relative CS* drop-down menu; *Offset* is the default command.

2. Initially, specify **(4 mm, 0, 10 mm)** as the **Origin** location and create the coordinate system.
3. Double-click **RelativeCS1** under *Coordinate Systems* in the History Tree to access the *Properties* dialog box.
4. Change the **Name** and **Origin** values as shown in the following figure and then close the *Properties* dialog box:

Coord System					
	Name	Value	Unit	Evaluated Value	Description
Type		Relative			
Name		bend_CS			
Reference CS		Global			
Mode		Axis/Position			
Origin		bend_radius ,0mm ,10mm		4mm , 0mm , 10mm	
X Axis		1 ,0 ,0	mm	1mm , 0mm , 0mm	
Y Point		0 ,1 ,0	mm	0mm , 1mm , 0mm	

Figure 2-4: Controlling the Relative CS Origin by the Variable *bend_radius*

Copy and Rotate Bottom Leg

The next step is to create a copy of the bottom leg and rotate it to create the leg at the opposite end of the coax bend.

1. Make sure that **bend_CS** is the “working” coordinate system.
2. Select all objects.
3. On the **Draw** ribbon tab, click  **Thru Mirror** (*Mirror Duplicate*). Specify **(0, 0, 0)** as the **Base Position**, **(0, 0, 1)** as the **Normal Position**, and complete the duplication.
4. Close the *Properties* dialog box if it appears automatically after drawing the cylinder.
5. Deselect all original objects and select all new objects (those with “_1” appended to the name).

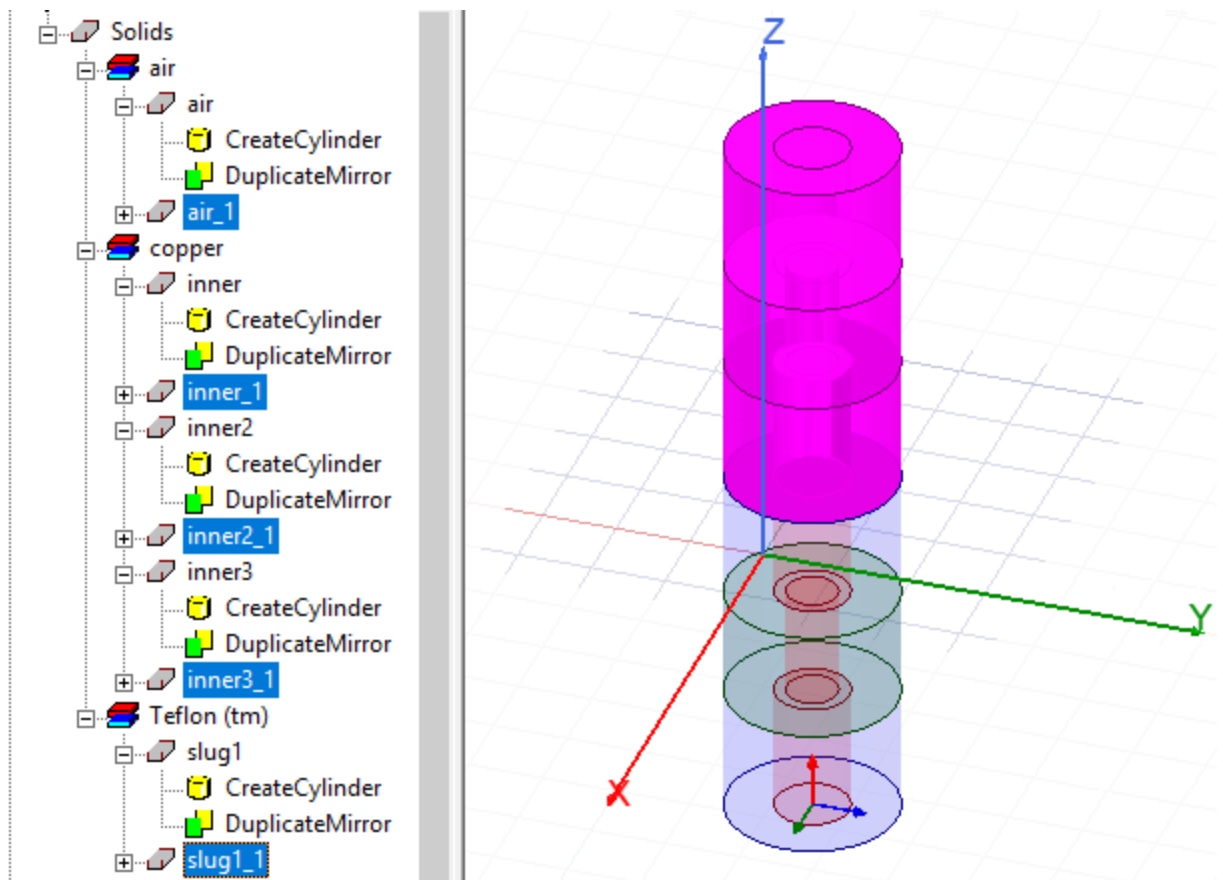



Figure 2-5: Selecting New Leg Objects

- On the **Draw** ribbon tab, click  **Rotate**. Then, rotate the selected objects around the **Y Axis** using the **bend_angle** variable for the **Angle** specification:

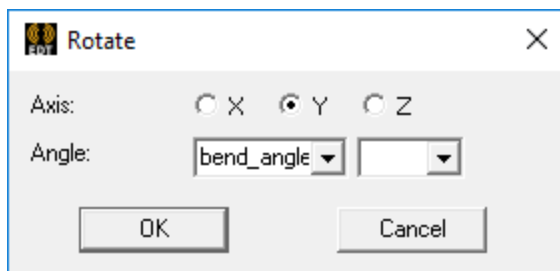

Figure 2-6: Rotate Command Settings

- Again, close the *Properties* dialog box if it appears automatically after rotating the objects.
- Change the **Name** of *slug1_1* to **slug2** and then clear the selection.

The model should now look like the following figure:

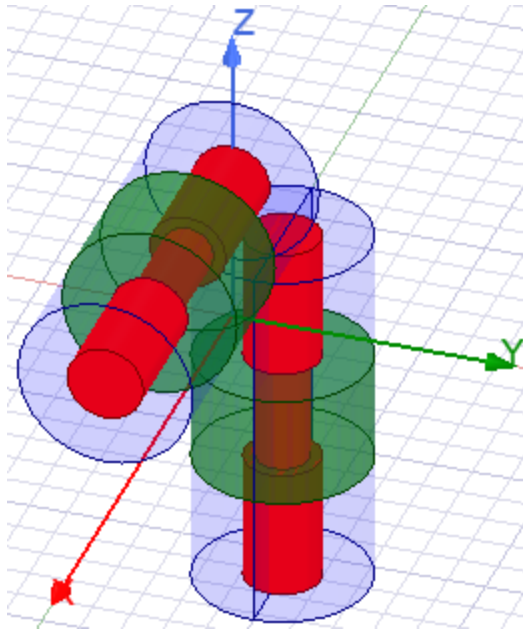

Figure 2-7: Leg Duplicated

Create Bend

Now create the central part, the bend that connects the two legs. Then, unite the air objects into one contiguous object and the conductors into another contiguous object.

1. Switch to an **Isometric** view of the model. This orientation provides a better view of the faces to be selected than the default *Trimetric* view does.
2. Select the top faces of the bottom leg, as shown in the following image. Be sure to select the faces of both the *copper* and the *air* part, which overlap each other.

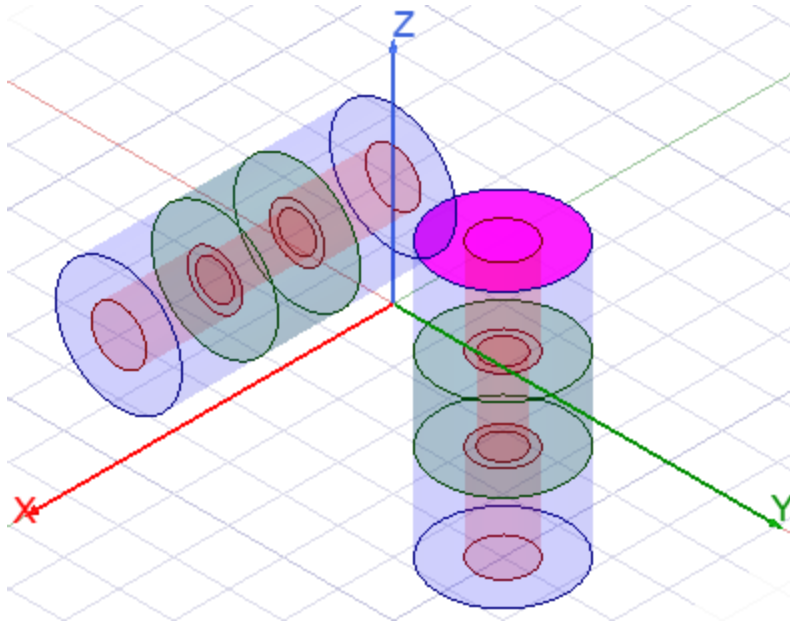



Figure 2-8: Selecting Faces for Creating the Bend

3. On the **Draw** ribbon tab, click  **Surface** > **Create Object From Face**.
4. Make sure that:
 - The new *Unassigned* sheet objects are selected
 - *Bend_CS* is still the working coordinate system
5. On the **Draw** ribbon tab, click  **Sweep around axis** and sweep the selected sheet objects around the **Y Axis** using the **bend_angle** variable for the **Angle** specification.

Note:

The *Draft type* selection does not matter when no *Draft angle* is specified.

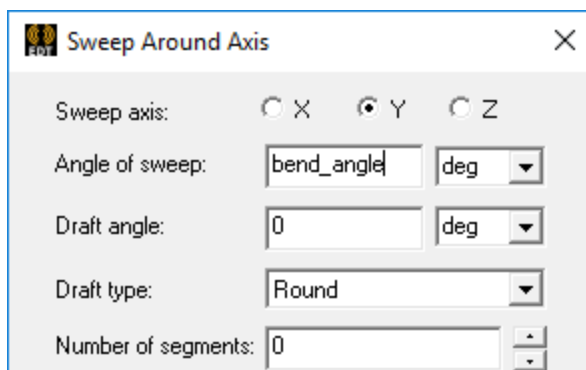

Figure 2-9: Sweep Around Axis Settings

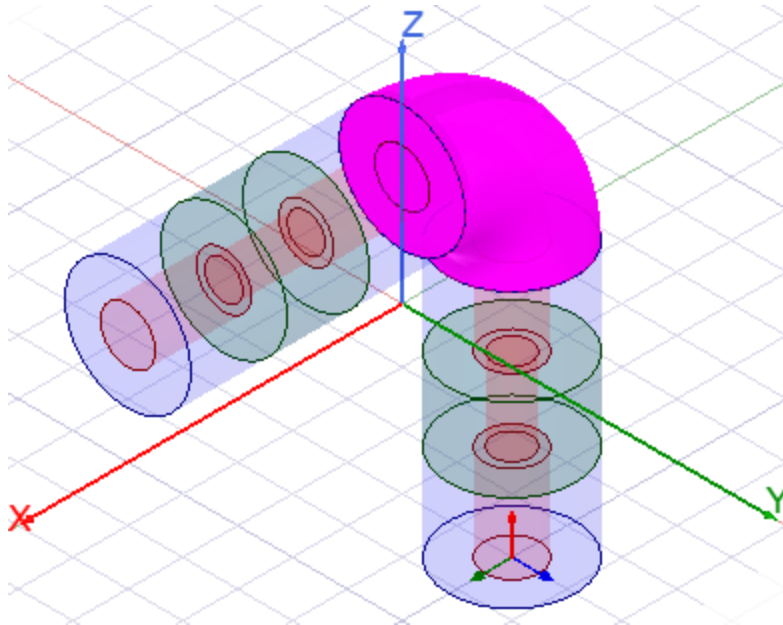



Figure 2-10: Bend Created

Unite Objects

Now, unite the conductors into one contiguous object and also unite the air objects into another contiguous object.

1. In the History Tree, select all copper objects (being sure to select **inner** first) and  **Unite** them.

The first item selected determines the attributes of the united object (including name, material, and appearance).

2. In the same manner, select and  **Unite** the **air** objects.

The completed geometry and History Tree should look like the following image:

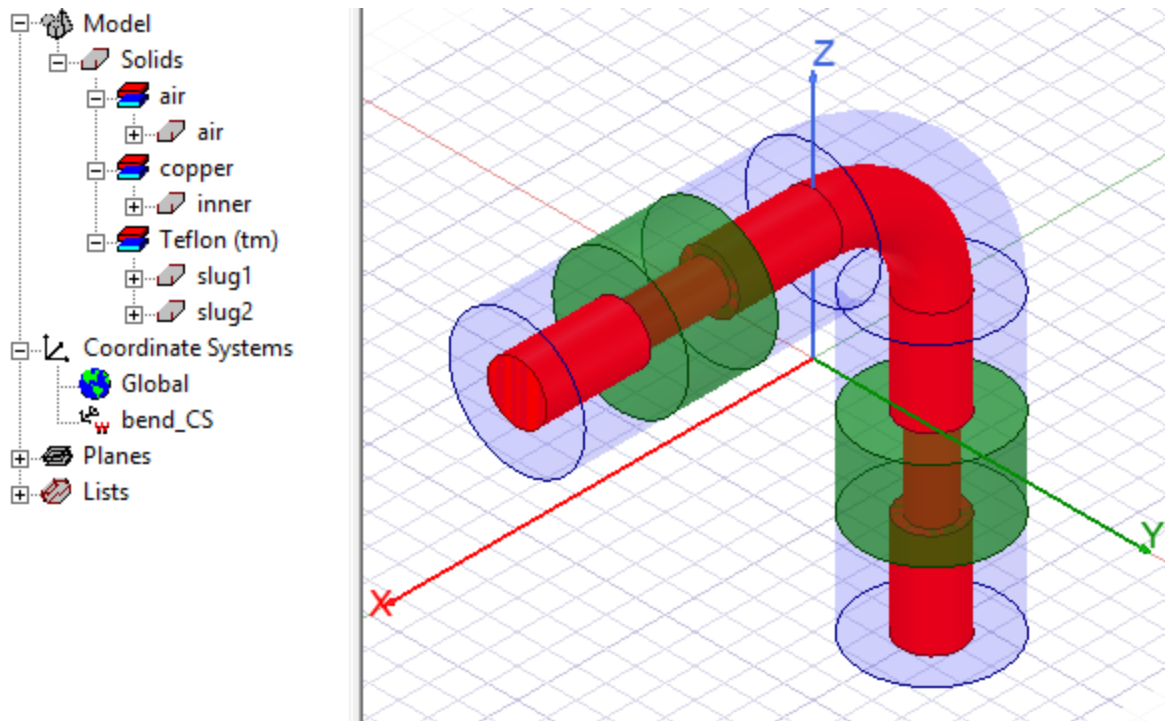



Figure 2-11: The Completed Geometry

Now that you have completed the geometry, experiment with different variable values to see the effects. Then, restore the specified bend angle and radius values before proceeding to the next topic.

3. Try a few different values for the **bend_angle** and **bend_radius** variables to make sure that the model remains correct when these variables change.

Note:

The *bend_angle* values may be positive or negative but must be nonzero. The *bend_radius* values must be positive and at least 2.3 mm to keep from invalidating the air object (because 2.3 mm is the radius of the cylindrical air object). Similarly, a *bend_radius* less than 1 mm would also invalidate the inner conductor, which has a 1 mm radius.

4. Restore the original **bend_angle** and **bend_radius** values of **90 degrees** and **4 mm**, respectively.
5.  **Save** the project.

Enable Material Overrides

We will take advantage of Ansys Electronics Desktop's ability to resolve material intersections. The program automatically resolves element materials when an object is fully contained within another object, in which case the fully contained object's material is used in the region of overlap. However, to resolve various partial object intersections, when one object is not fully contained within another, you must enable an optional material override setting. This option is found in the *Design Settings* dialog box. When enabled, conductors take precedence over dielectrics in regions of overlap. The alternative solution is to subtract one object from the other to eliminate the overlap.

In this model, the inner conductor intersects the two Teflon slugs, but no object among these three is completely contained within one of the others. Therefore, these intersections cannot be resolved without enabling material overrides.

1. From the menu bar, click **HFSS > Design Settings**.
2. In the *Set Material Override* tab of the dialog box that appears, ensure that **Enable material override** is selected.

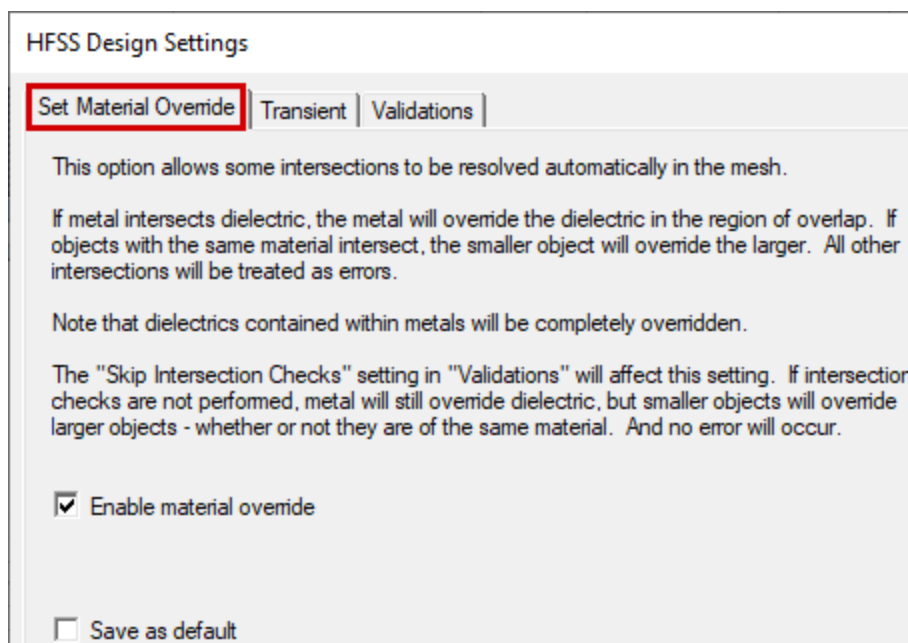

Figure 2-12: Set Material Override tab of the HFSS Design Settings Dialog Box

Note:

This option will cause the *inner* conductor material to take priority over *slug1* and *slug2* where they intersect. While the *Enable material override* option is not needed to resolve the overlapping *air* and *slug* objects or the overlapping *inner* conductor and *air* objects, it is needed to resolve the *inner* conductor and *slug* intersections.

- Optionally, if you wish to have this option enabled by default for all future projects, select **Save as default**.
- Click **OK**.

Create Air Object Cross Section

Next, you will section the air object along the XZ plane to create a sheet object on which you can overlay field results. Then, you will add the sheet object to an object list for field plotting.

- Select the **air** object from the History Tree:

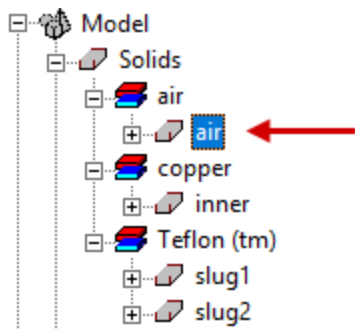

Figure 2-13: Select Object to Section

- On the **Draw** ribbon tab, click **Surface > Section**.
- Select the **XZ** plane and click **OK** to create the section:

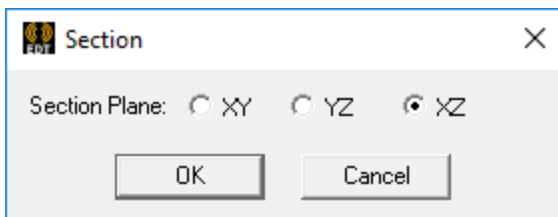

Figure 2-14: Choosing the Section Plane

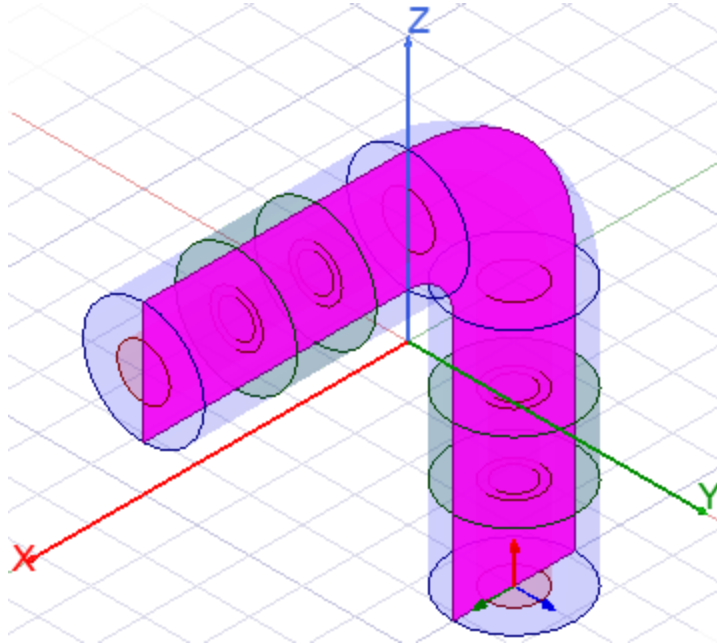

Figure 2-15: Sheet Object *air_Section1* Created

4. With the new sheet object (**air_Section1**) still selected, use the menu bar and click **Modeler > List > Create > Object List**.

ObjectList1 appears under *Lists* in the History Tree.

5. Change the **Name** of *ObjectList1* to **PlotFields**.

Excitations

The process of assigning excitations, defining terminals, setting the renormalization option, and choosing whether ports are active or passive varies depending on a particular program option (specifically, *Auto-assign terminals on ports*). For your experience to be consistent with the procedure given in this guide, you will first verify that the *Auto-assign terminals on ports* option is **not** selected. Then, you will assign two wave port excitations, one active and one passive.

1. On the **Desktop** ribbon tab, click  **General Options** and select **HFSS > Boundary Assignment** in the tree on the left side of the *Options* dialog box that appears.
2. Ensure that the **Auto-assign terminals on ports** option is **not selected** and click **OK**.

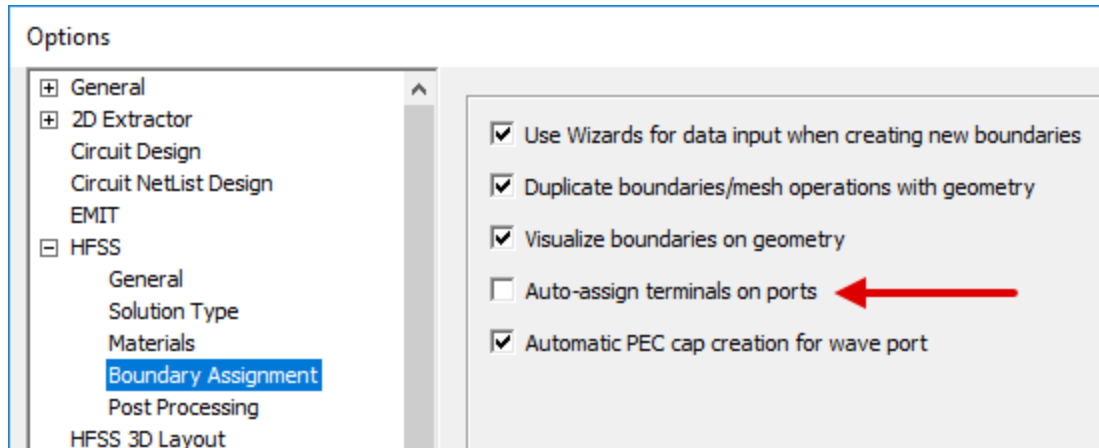

Figure 2-16: HFSS Boundary Assignment Options

3. Assign a **Terminal Wave Port** excitation to the +X end face of the coax, selecting only the *air* face, not the conductor face. Select the **Do not renormalize** option in the *Wave Port* dialog box.
4. Assign a **Terminal Wave Port** excitation to the bottom (-Z) end face of the coax, again selecting only the *air* face. This time, clear the **Active** option to make this a *passive* port. Also, select the **Do not renormalize** option as you did in the previous step.

Note:

Passive ports act as terminations. Making this port passive reduces the output data and the solution time. S, Y, and Z parameters are not computed for passive terminals, significantly reducing the number of matrix coefficients.

5. Right-click *Excitations* in the Project Manager and choose **Auto Assign Terminals**. In the *Reference Conductors for Terminals* dialog box, ensure that *Use as Reference* is cleared (*not* selected) and click **OK**.

At each end, the face of the *inner* conductor is automatically defined as the terminal. The two ports and the associated terminals are listed under *Excitations* in the Project Manager. The passive port and its terminal have the all gray icons:

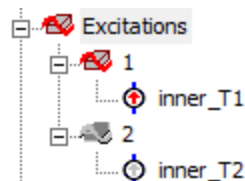



Figure 2-17: Excitations Assigned

6.  **Save** the project.

Solution Setup

The goal is to perform a TDR analysis with a high spatial resolution.

1. On the **Simulation** ribbon tab, click  **Setup** (*Add Solution Setup*).
2. Under the **General** tab, accept the defaults. A mesh will be created through frequency-domain adaptive passes. The adapt frequency will be chosen automatically based on the TDR rise time you specify next. Mixed element orders and the iterative solver will be employed.

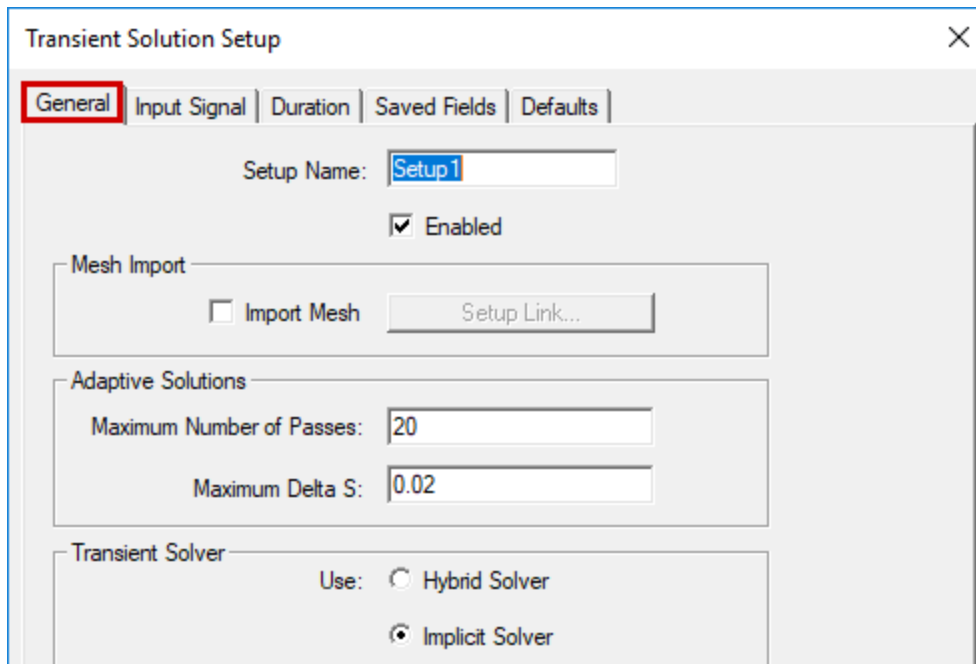

Figure 2-18: Setup for Mesh Generation

3. Under the **Input Signal** tab, choose **TDR** from the **Function** drop-down menu and specify **15 ps** as the **Rise Time**.



Figure 2-19: Input Signal Setup for TDR Function

Note:

A time of 15 ps corresponds to a one-way travel distance of 4.5 mm in air and 3.1 mm in Teflon or a round-trip covering half the stated distances (that is, 2.25 mm for air and 1.55 mm for Teflon). This calculation provides an idea of the expected spatial resolution. The rise time specified here is the 10-90% rise time of the step function (the green line in the plot below). The actual excitation will be its derivative (the red line in the plot below). After the input pulse, steady state conditions are eventually achieved. The simulation ends when fields everywhere in the model are observed to have fallen below a specified level.

- Under the **Duration** tab, ensure that **-40 dB** is specified as the **Target Residual**. This setting means that the simulation will end when the maximum field value in the model has fallen to 0.01 (or 1%) of its all-time high. In addition, specify a duration of **At most 400 ps**. This is long enough for the signal to travel the length of the connector several times.

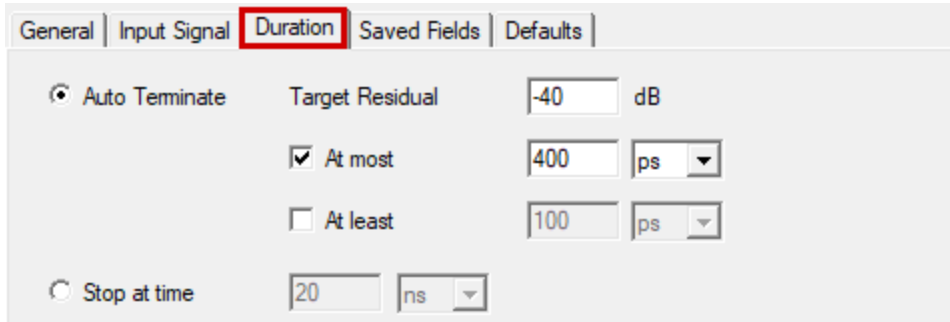

Figure 2-20: Duration Settings for Analysis

- Under the **Saved Fields** tab, select **PlotFields** to make HFSS save the fields on the objects in this list for subsequent field overlay plotting. In addition, specify to **Save fields every 2 ps**.

The 2 ps save increment is a small-enough fraction of the input signal duration to provide reasonably smooth field animations while limiting the output data and solution time.

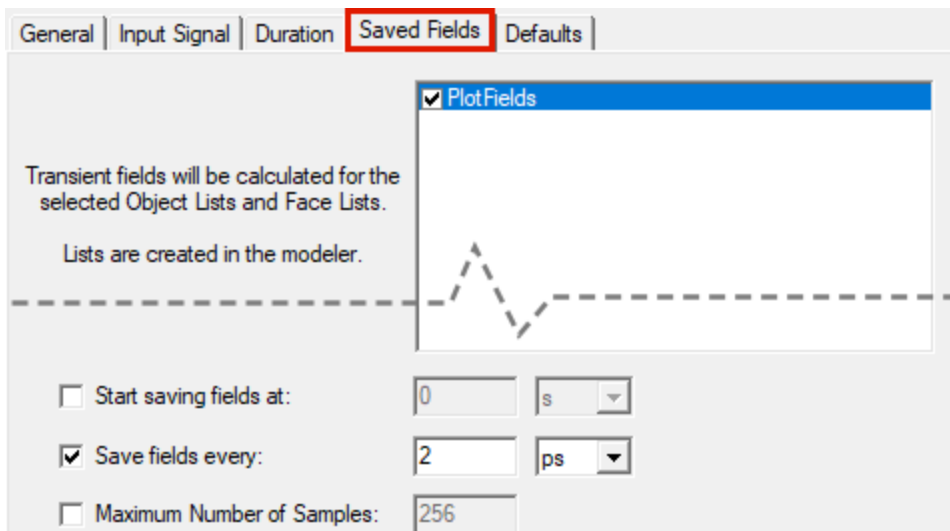



Figure 2-21: Saved Fields Settings.

- Click **OK**.
-  **Save** the project.



The model construction and analysis setup are complete. You will next run the simulation and evaluate the results.

3 - Simulation and Results

In this chapter, you will validate and run the simulation. Then, you will evaluate the results, including the post processing following tasks:

- Create a TDR impedance plot (time domain)
- Interpret the TDR impedance results
- Create an S-parameter plot (frequency domain)
- Create a field overlay (time domain)
- Perform a parametric sweep to explore the influence of the design variables (*bend_radius* and *bend_angle*) on the results.

Validate and Analyze:

1.  **Validate** the analysis setup. There should be no errors or warnings.
2. Run the Simulation ( **Analyze All**).

The simulation will take one to two minutes to complete using a reasonably current computer workstation.

View the Results:

While the solution is still progressing, you can begin to view the results. Plots will fill in as the results become available.

TDR Impedance Plot

1. Create a **Terminal Solution Data Report** in the form of a **Rectangular (2D)** plot. Specifically, create a report of the TDR Impedance, **TDRZ**, set up as shown below:

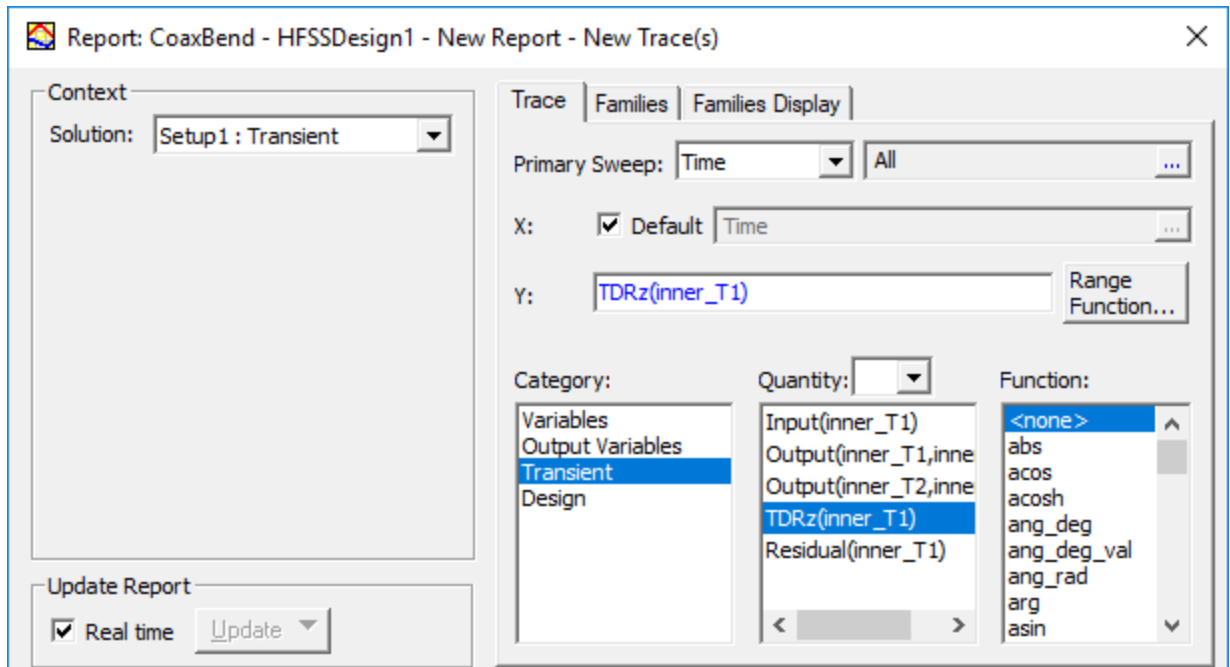

Figure 3-1: Settings for TDR Impedance Plot at Terminal *inner_T1*

2. Customize the plot settings to produce the following X axis scaling:
 - **X Max = 400 ps**
 - **X Spacing = 100 ps**
 - **Minor Tick Divs = 5**
3. Add a **Marker** to each of the first five minimal impedance points (between time = 40 ps and time = 220 ps).

The resulting TDR report, with the customized axes and markers added, is shown below:

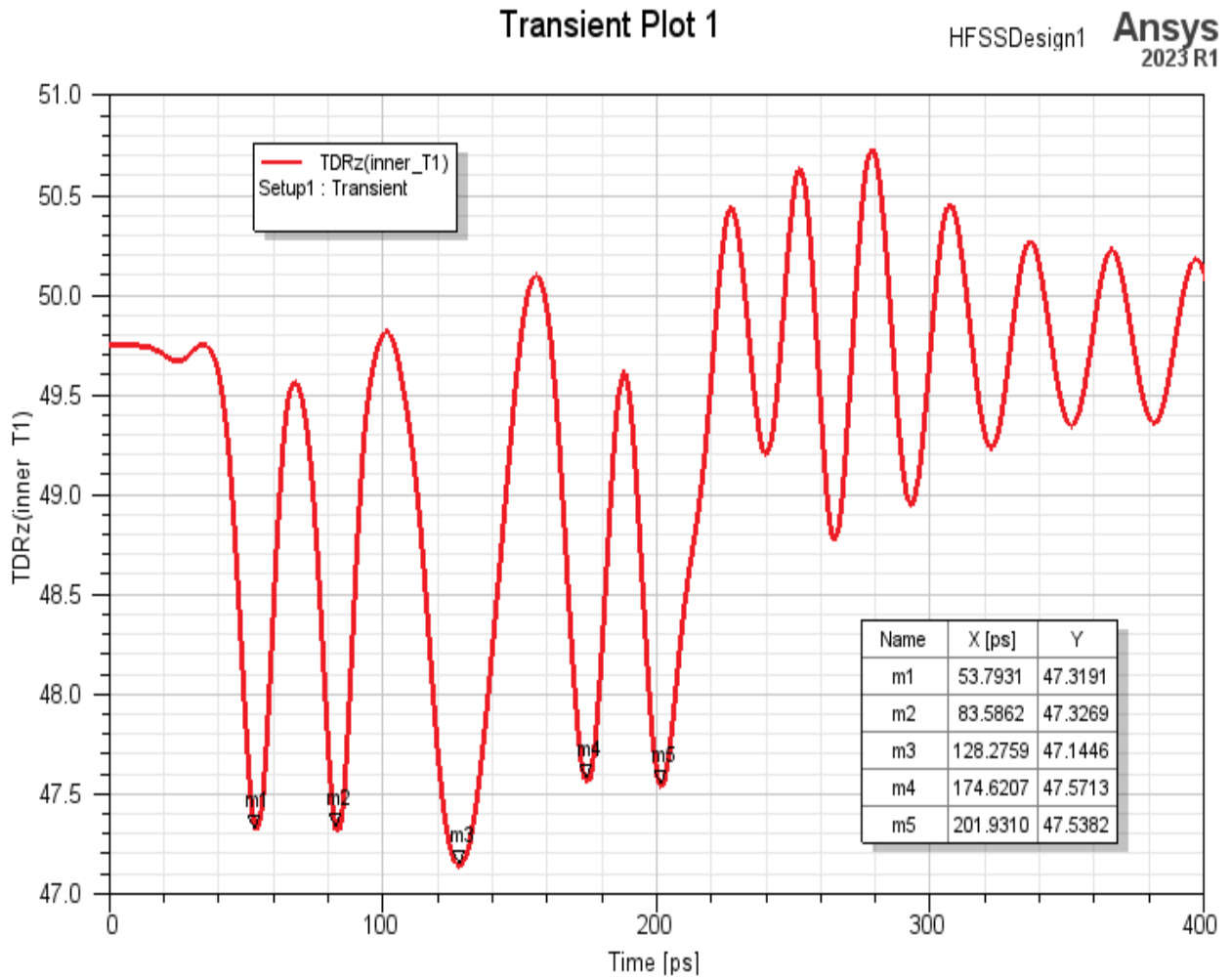

Figure 3-2: TDR Impedance at Terminal *inner_T1* vs. Time

Interpretation of TDR Impedance Plot

The report starts, for $t=0$, with an impedance just under 50Ω . This is indeed the characteristic impedance of the coaxial line.

At impedance discontinuities, part of the input signal is reflected. These reflections, after traveling back, reach terminal *inner_T1* and are observed there. From these observations, the characteristic impedances along the transmission line can be computed.

In TDR measurements, the input voltage is a step function with a finite rise time, and the impedance follows from the equation:

$$(0) Z = Z_0 * (\text{stepinput} + \text{reflection}) / (\text{stepinput} - \text{reflection}) \quad (\text{Eq. 1})$$

where Z_0 is the characteristic impedance of the transmission line at the terminal.

Note:

This equation will give $Z = 0$ for a short circuit, $Z = Z_0$ for a matched line, and $Z = \infty$ for an open termination.

In HFSS Transient, the input voltage is the time derivative of a step function with a finite rise time. This input is instrumental in the detection of the steady state by means of the field residual, which will go to zero. The impedance is computed from an equation similar to *Eq. 1*, but with appropriate time integrations to obtain the response to a step function.

If you wish to verify the correctness of this approach, you can define a step function with a finite rise time by means of a dataset, and create your own output variable for TDRZ based on *Eq. 1*.

The times in the TDRZ plot are related to the distances from terminal *inner_T1* by taking the two-way travel time of the signal (from the terminal to a discontinuity and back) into account. We also have to take into account that the input signal has a finite rise time. From the *Input Signal* tab of the *Transient Solution Setup*, we know that the *input signal* has its maximum rate of change at 30 ps. See the figure [Input Signal Setup for TDR Function](#) in the *Solution Setup* topic. So we have to add 30 ps to the two-way travel times when computing distances from terminal *inner_T1*.

The rate of electromagnetic wave propagation in a vacuum and for the two dielectric materials in this model are as follows:

- **Vacuum:** 2.99792×10^{11} mm/second
- **Air:** 2.99702×10^{11} mm/second
- **Teflon:** 2.06876×10^{11} mm/second

The air between the terminals and slugs has a length of 3.5 mm, the slugs are 3 mm long each, and the length of the bend's centerline arc length is 6.2832 mm (3.1416 mm from the end to the midpoint along the arc). With these considerations, we can construct the following table.

Table 1: Linking distances along the line and times in the TDR report

Location	Distance (mm)	30 ps + Two-Way Travel Time (ps)	Note
T1	0	30	
Start of first slug	3.5	$30 + 23.357 = 53.357$	Plot Marker <i>m1</i>
End of first slug	6.5	$53.357 + 29.003$ (at lower speed in Teflon) = 82.360	Plot Marker <i>m2</i>
Start of bend	10	$82.360 + 23.357 = 105.717$	
Middle of bend	13.1416	$105.717 + 20.965 = 126.682$	Plot Marker <i>m3</i>

Location	Distance (mm)	30 ps + Two-Way Travel Time (ps)	Note
End of bend	16.2832	$126.682 + 20.965 = 147.647$	
Start of second slug	19.7832	$147.647 + 23.357 = 171.004$	Plot Marker <i>m4</i>
End of second slug	22.7832	$171.004 + 29.003$ (at lower speed in Teflon) $= 200.007$	Plot Marker <i>m5</i>
T2	26.2832	$200.007 + 23.357 = 223.364$	

Observations:

- The positions of the TDR impedance plot markers correspond well to the discontinuities along the signal path. Consider the above calculated time for the pulse to reach the end of the second slug and travel back to the terminal (200.007 ps). Compare this with the result for marker *m5* on the TDRz plot (201.931 ps). The deviation is less than 1%.
- Inside the slugs, the characteristic impedance is close to 50 Ω, which is visible between markers *m1* and *m2* and also between markers *m4* and *m5*. The connector was carefully designed this way by adjusting the radius of the inner conductor to compensate for the change in material from air to Teflon. Nevertheless, the geometrical discontinuity produces a reflection. The reflection is capacitive: the edges of the discontinuity in the inner conductor can hold a little excess charge.
- The bend, although created by sweeping a 50-Ohm cross section, turns out to have an impedance slightly less than 50 Ohm. This is visible in the plot at marker *m3*. Apparently, sweeping around a curved path affects the characteristic impedance.
- Beyond 220 ps, the report shows diminishing oscillations around 49.8 Ω. These oscillations are due to residual fields undergoing multiple reflections between discontinuities before reaching terminal *inner_T1*. These oscillations are not meaningful in a TDR analysis (we could have stopped the simulation earlier). However, the remaining simulation time is important in the determination of S-parameters. In general, if a time-domain simulation is stopped too early, inaccuracies show up in the S-parameters in the form of small oscillations superimposed on the true S-parameter versus frequency curve.

S-Parameter vs. Frequency Plot

The next plot is in the frequency domain (spectral) rather than the time domain (transient). S-parameters are only available for active ports.

1. Create a **Terminal Solution Data Report** in the form of a **Rectangular (2D)** plot. Specifically, create a report of the **S₁₁** parameter (in dB) vs. frequency, set up as shown below:

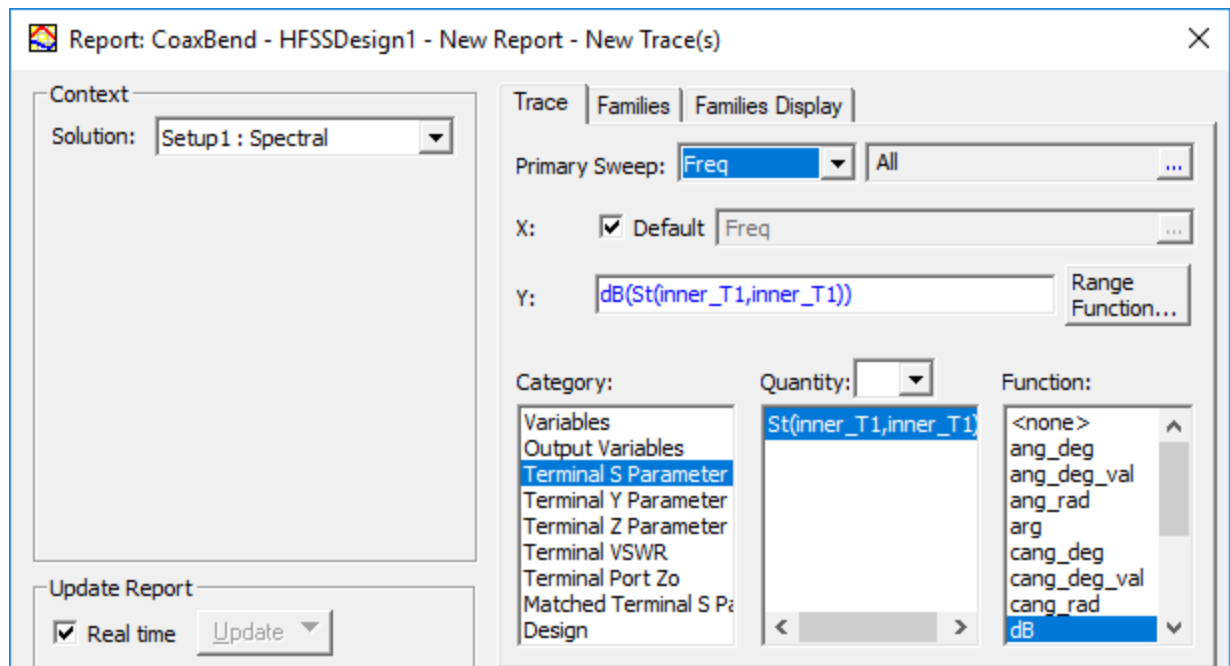

Figure 3-3: S-Parameter vs. Frequency Plot Settings

2. Adjust the **X Axis** scaling to show **60 GHz Max** and **10 GHz Spacing** with **5 Minor Tick Divs**.

The resulting plot is shown in the following figure:

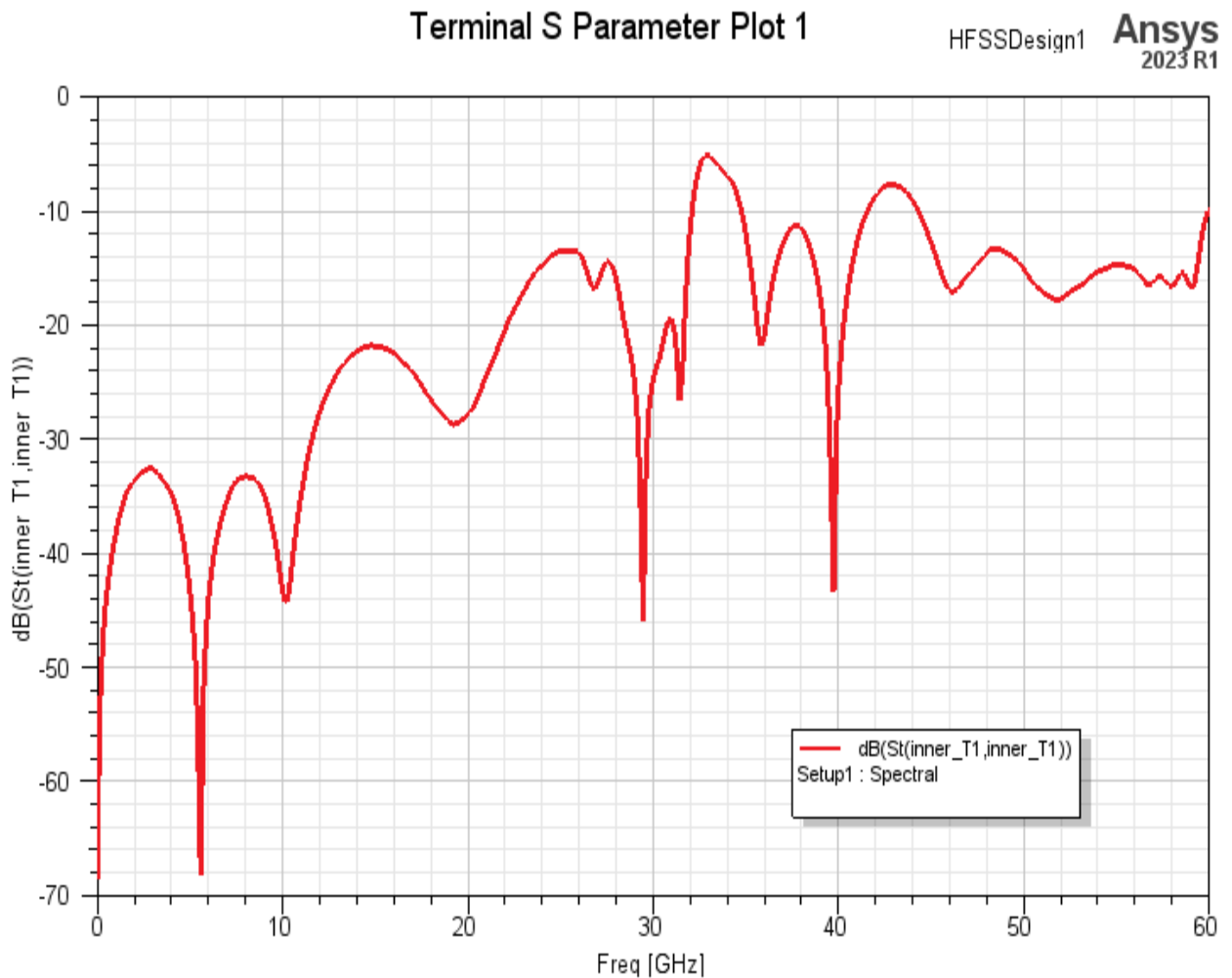





Figure 3-4: S-Parameter vs. Frequency Plot

Note:

This S-parameter indicates the signal reflection at the active terminal (*inner_T1*). The observed trend is that signal reflection increases with frequency. Notice that the performance of the coax is poor beyond about 32 GHz. The poor performance is due to the coaxial line supporting higher-order modes at higher frequencies.

E-Field Overlay

1. Bring the Modeler window back to the foreground.
2. On the **Draw** ribbon tab, click  **Orient** >  **Left (+Y)**.
3. Under *Model* > *Sheets* > *Unassigned* in the History Tree, select **air_Section1**.
4. On the **Draw** ribbon tab, click  **Show only selected objects in active view**.

This action prevents the air and the two slugs from obscuring the field overlay you're about to add. Additionally, the inner conductor is suppressed, since it will not have any field results overlaid.

5. Under *Lists* in the History Tree, select **PlotFields**.
6. In the Project Manager, right-click **Field Overlays** and select **Plot Fields** > **E_t** > **Mag_E_t**.
7. In the *Create Field Plot* dialog box, select **50ps** from the **Time** drop-down menu (or just type in this value) and click **Done**.

The E-field overlay appears on the model. The selected *Time* corresponds to the point at which the field is centered inside the first slug.

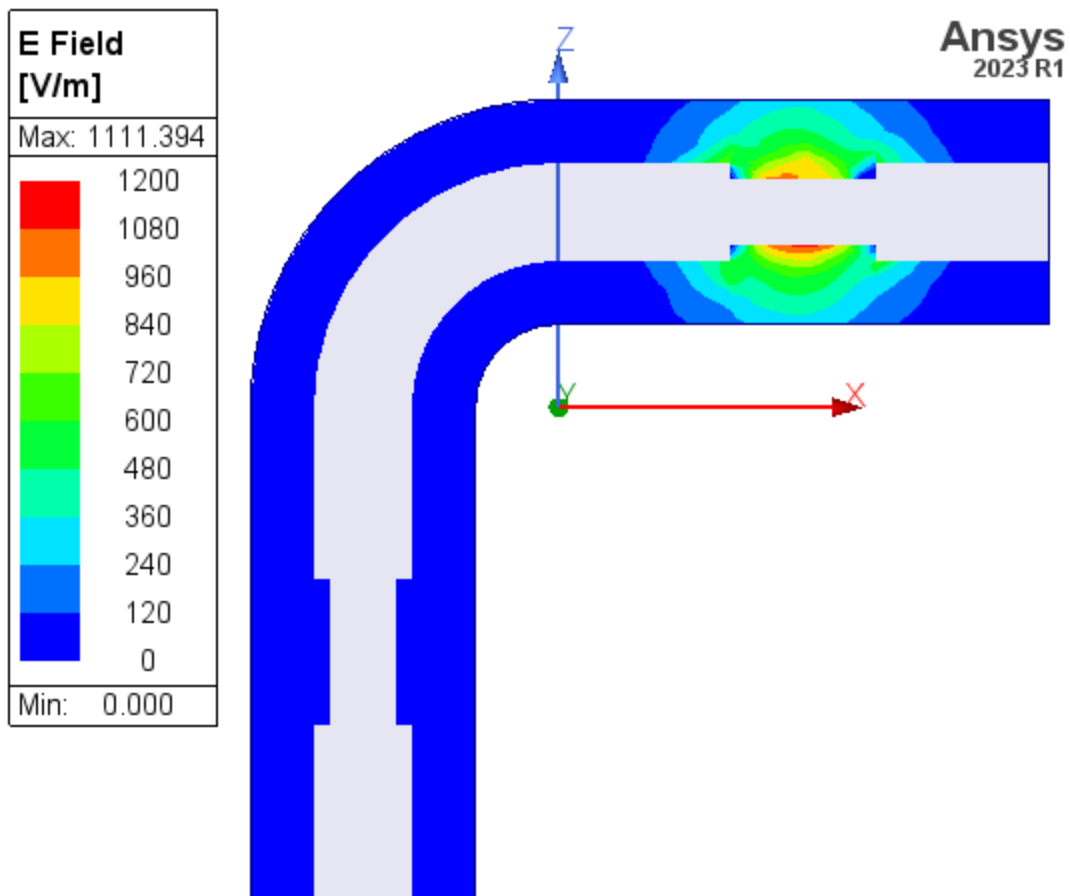

Figure 3-5: E Field Overlay (Time = 50 ps)

8. Double-click the plot legend and adjust the E-Field scale to limit the **Max** value to **600 V/m** (a little more than half of the peak magnitude).

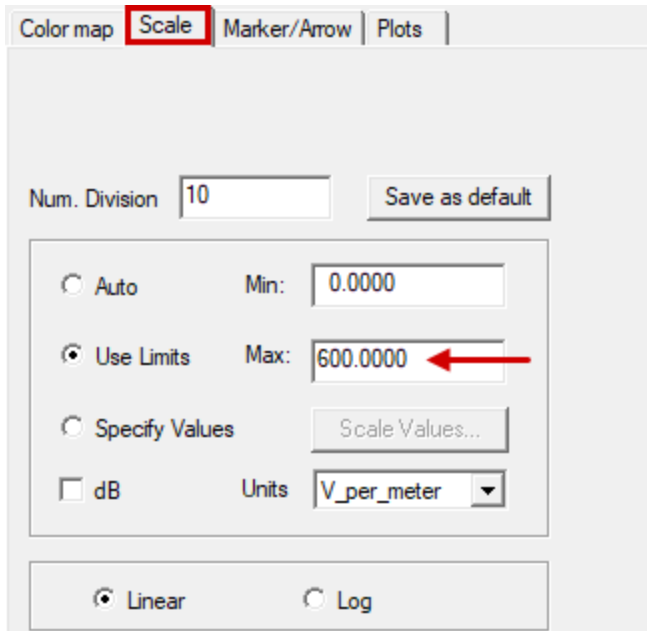
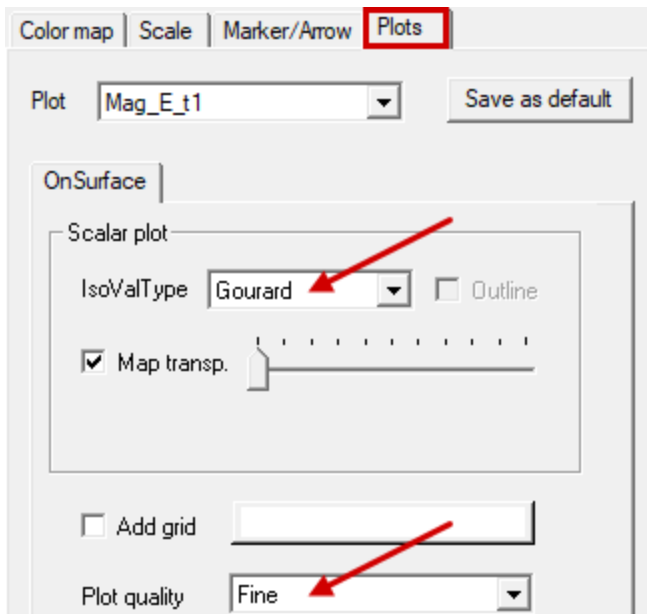

Figure 3-6: Scale Settings for Field Overlay Plot

You will next animate the field plot. This scale adjustment will make visualization of the weaker late field effects visible. The weaker fields would appear as solid blue beyond 200 ps with the scale set for the full field range.

9. Adjust the settings under the Plots tab as shown below for a smoother, higher quality overlay plot:



10. Under *Field Overlays > E Field* in the Project Manager, right-click **Mag_E_t1** and choose **Animate**. Specify the following properties in the *Create Animation Setup* dialog box:
 - **Start = 20ps**
 - **Stop = 380ps**
 - **Steps = 180**

This setup creates an animation frame for every calculated field time point within the specified range (2 ps increments). However, you could specify any number of steps. The results are interpreted for time points between calculated ones.

After you click *OK*, there will be a short delay while the animation frames are computed, after which the animation begins to play.

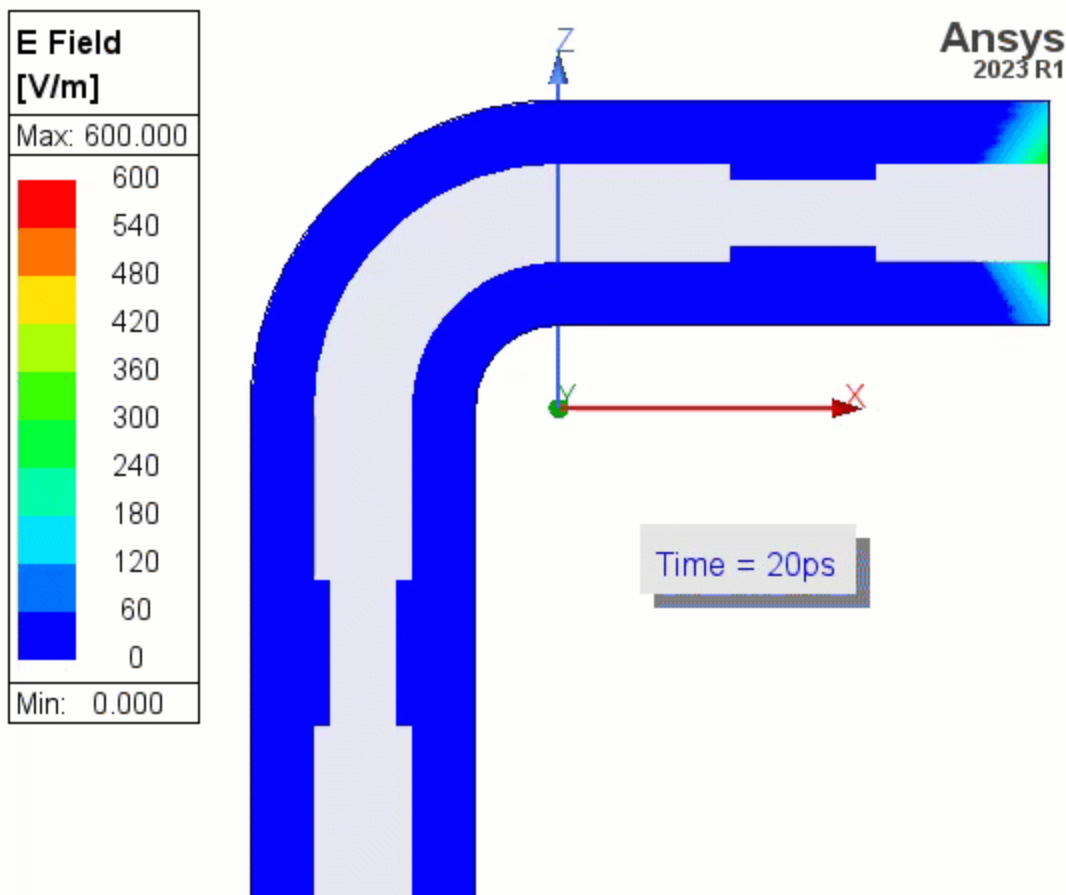

Figure 3-7: Animated E-Field Overlay

11. Use the available controls to stop, resume, reverse, change the playback speed, or to select a particular frame to view.
12. **Close** the *Animation* dialog box when you've finished reviewing the animated fields.

Parametric Sweep

Since you've included two variables in the design, you can define parametric sweeps and explore the influence of these variables on the results.

1. On the **Simulation** ribbon tab, click  **Optimetrics** >  **Parametric**.
2. Under the *Sweep Definitions* tab of the *Setup Sweep Analysis* dialog box, click **Add** and define a **bend_angle** sweep in the *Add/Edit Sweep* dialog box, as shown below:

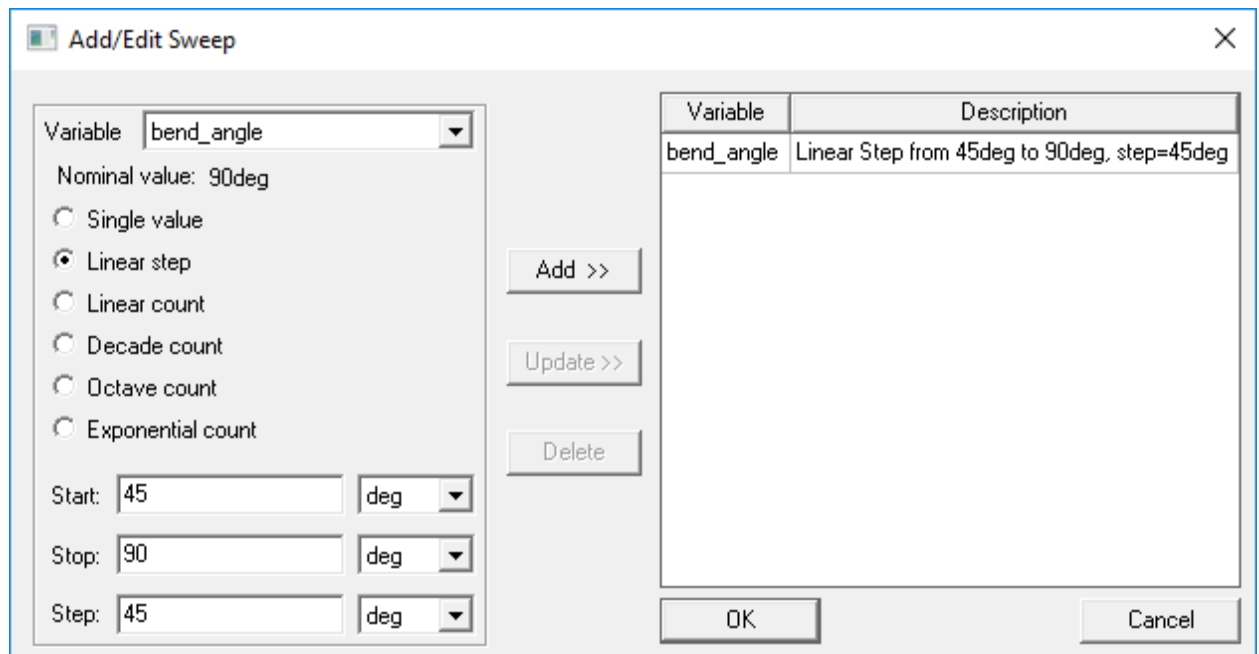

Figure 3-8: Adding a *bend_angle* Parametric Sweep

3. Click **OK** to add the sweep, but keep the *Add/Edit Sweep* dialog box open.
4. In the same manner, add a **bend radius** parametric sweep from **4 mm** to **8 mm** in **2 mm** steps and click **OK**.

The *Setup Sweep Analysis* dialog box should match the following figure:

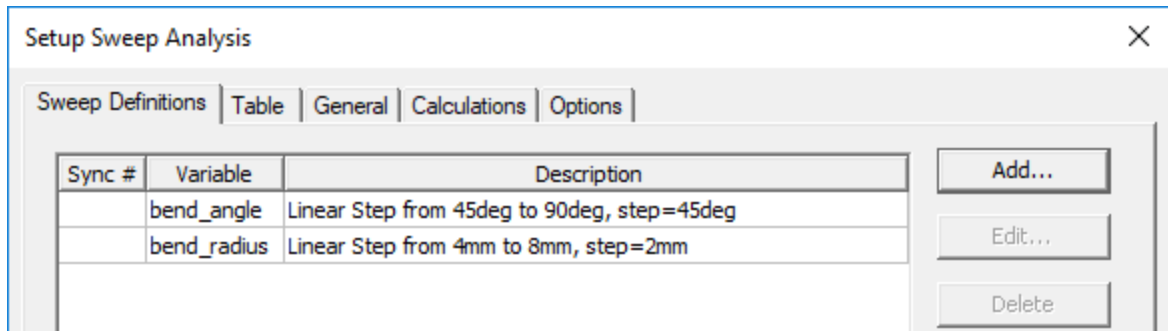

Figure 3-9: Parametric Sweeps Defined

For this exercise, you don't need to make any changes under the other tabs.

- Click **OK** twice to close the *Add/Edit Sweep* and *Setup Sweep Analysis* dialog boxes.
- Right-click **Optimetrics** in the Project Manager and selecting **Analyze > All Parametric**.

The parametric sweeps will take about eight to ten minutes to complete. There are a total of five variants to solve (2 angles x 3 radii - 1 variation that's already been solved). The results for a 4 mm bend radius and 90° bend angle are already known from the *Setup1* solution. Therefore, when *ParametricSetup1* is solved, this particular radius and angle variation need not be solved again.

Each new variation takes between 1 and 2.5 minutes to solve. The 90° angle takes longer to solve due to the greater number of elements and the longer signal path compared to the 45° angle. Similarly, the larger the radius, the greater the element count, signal path length, and run time.

Note:

Ignore the messages: *Transient Sweep Simulation, process hf3d: Port x supports an additional propagating and/or slowly decaying mode whose attenuation is 0.000e+00 and propagation constant is 1.395e+06.*

- In the same manner as shown in the topic [TDR Impedance Plot](#), create another **TDRz** transient plot, except this time, specify the following settings under the **Families** tab:
 - For the **bend_radius**, select only the **6mm** value.
 - For the **bend_angle**, select **All** values.

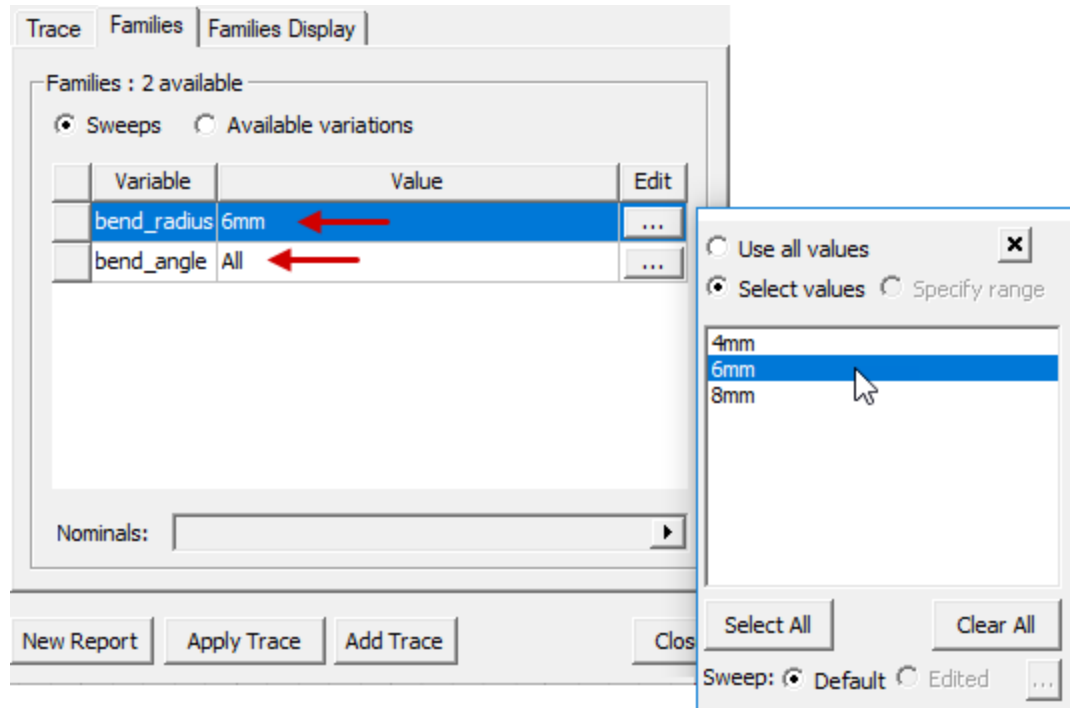

Figure 3-10: Selecting Variations of Interest for Vary Bend Angle Plot

8. Modify the plot to specify the following **Y Axis** settings:
 - **Number Format = Decimal**
 - **Field Width = 5**
 - **Field Precision = 1**
9. Modify the plot to specify the following **X Scaling** and **Y Scaling** settings:
 - **X Max = 400 ps**
 - **Y Min = 45.8 Ω**
 - **Y Max = 50.8 Ω**
10. From the Project Manager, rename this plot as **Vary Bend Angle**.

Your plot should be similar to the following figure:

Vary Bend Angle

HFSSDesign1

Ansys
2023 R1

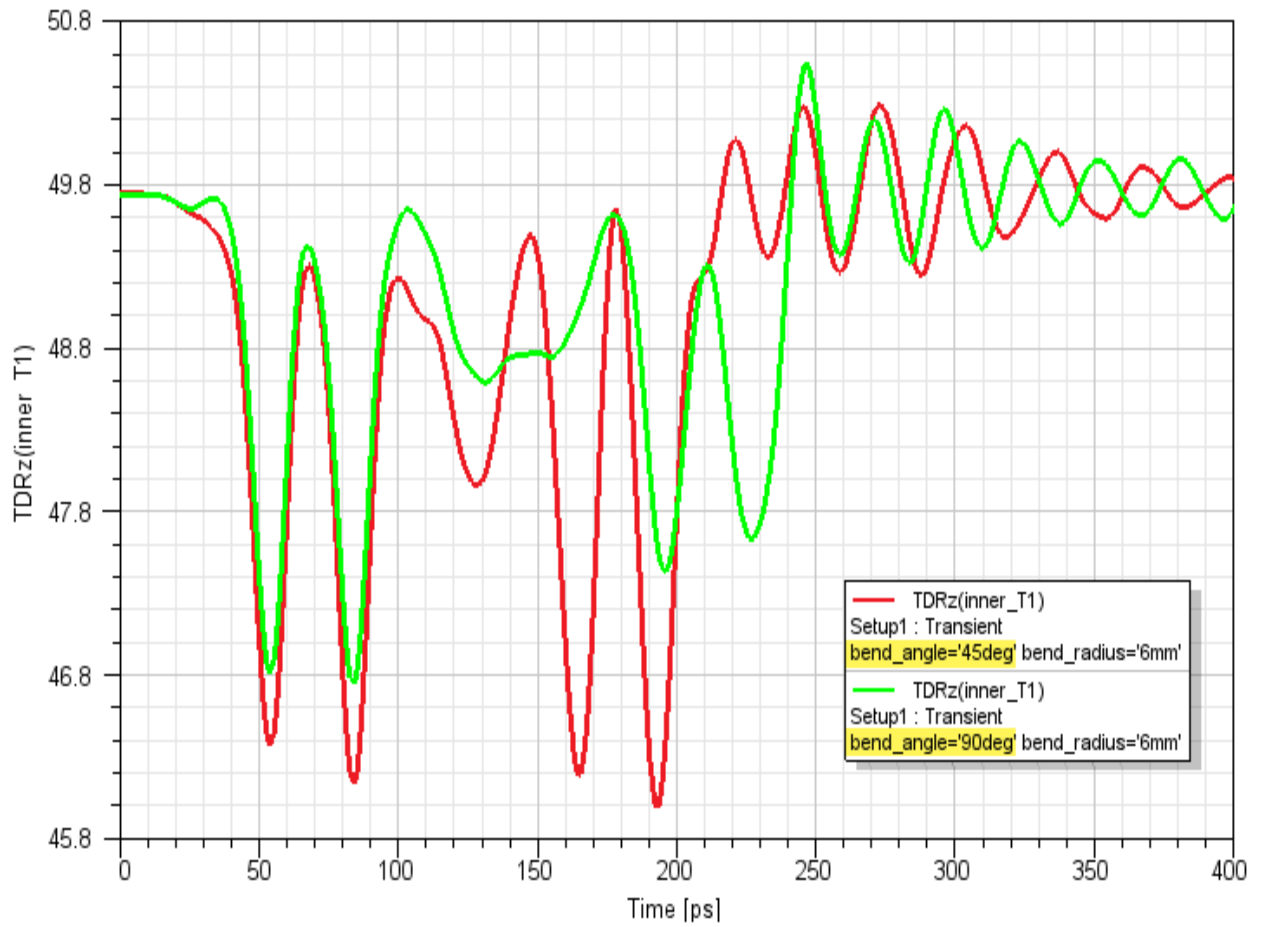

Figure 3-11: Effect of Bend Angle on TDR Impedance

Observations:

The area of interest is between 100 ps, which is approximately when the terminal sees the reflection from the field entering either bend, and 170 ps, which is approximately when the terminal sees the reflection from the field exiting the 90° bend. You can observe the following effects:

- The timing of the reflections from the discontinuities at the first slug remains the same, though the impedance results (Ω) differ.
- For the reflections from discontinuities at slug1, the bend, and slug2, deviation from the 50 Ω characteristic impedance is somewhat greater for the 90° angle (green curve) than for the 45° angle (red curve). However, the 90° curve is flatter during the portion of the curve associated with the bend.
- The reflections from the discontinuities at the second slug arrive earlier in time for the 45° angle, due to the shorter length of the bend that precedes it.

Some of the irregularities in the TDz traces may be due to contributions from fields that have bounced multiple times, particularly at later times, thus complicating the results

11. Create one more **TDRz** transient plot, except this time, specify the following settings under the **Families** tab:
 - For the **bend_radius**, select **All** values.
 - For the **bend_angle**, select only the **90deg** value.

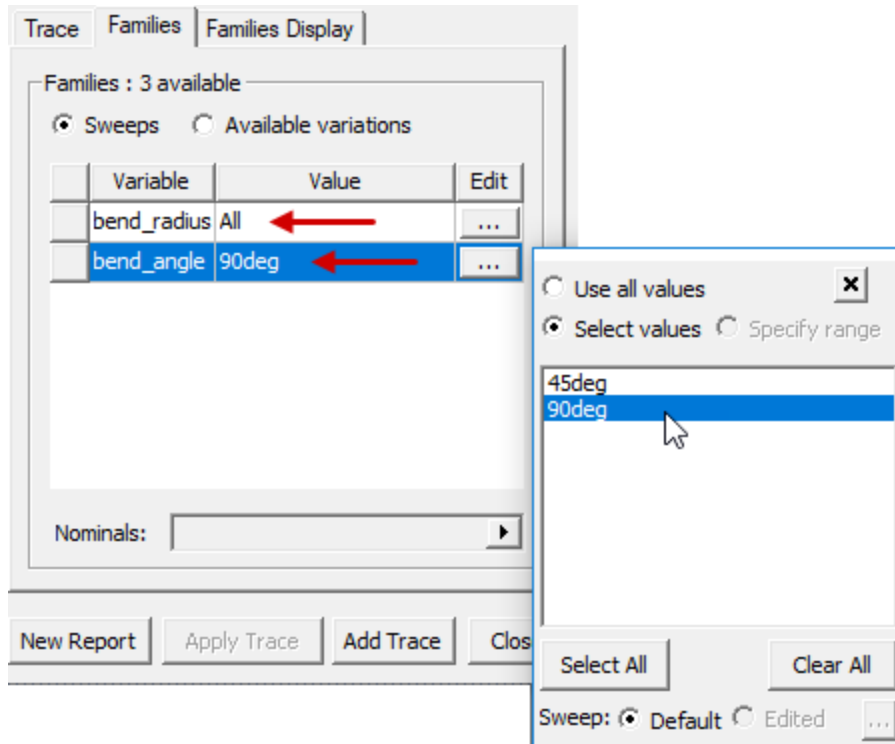

Figure 3-12: Selecting Variations of Interest for Vary Bend Radius Plot

12. Modify the plot to specify the following **Y Axis** settings:
 - **Number Format = Decimal**
 - **Field Width = 5**
 - **Field Precision = 1**
13. Modify the plot to specify the following **X Scaling** and **Y Scaling** settings, which are identical to those of the previous plot:
 - **X Max = 400 ps**
 - **Y Min = 46.6 Ω**
 - **Y Max = 50.9 Ω**
14. From the Project Manager, rename this plot as **Vary Bend Radius**.

Your plot should be similar to the following figure:

Vary Bend Radius

HFSSDesign1

Ansys
2023 R1

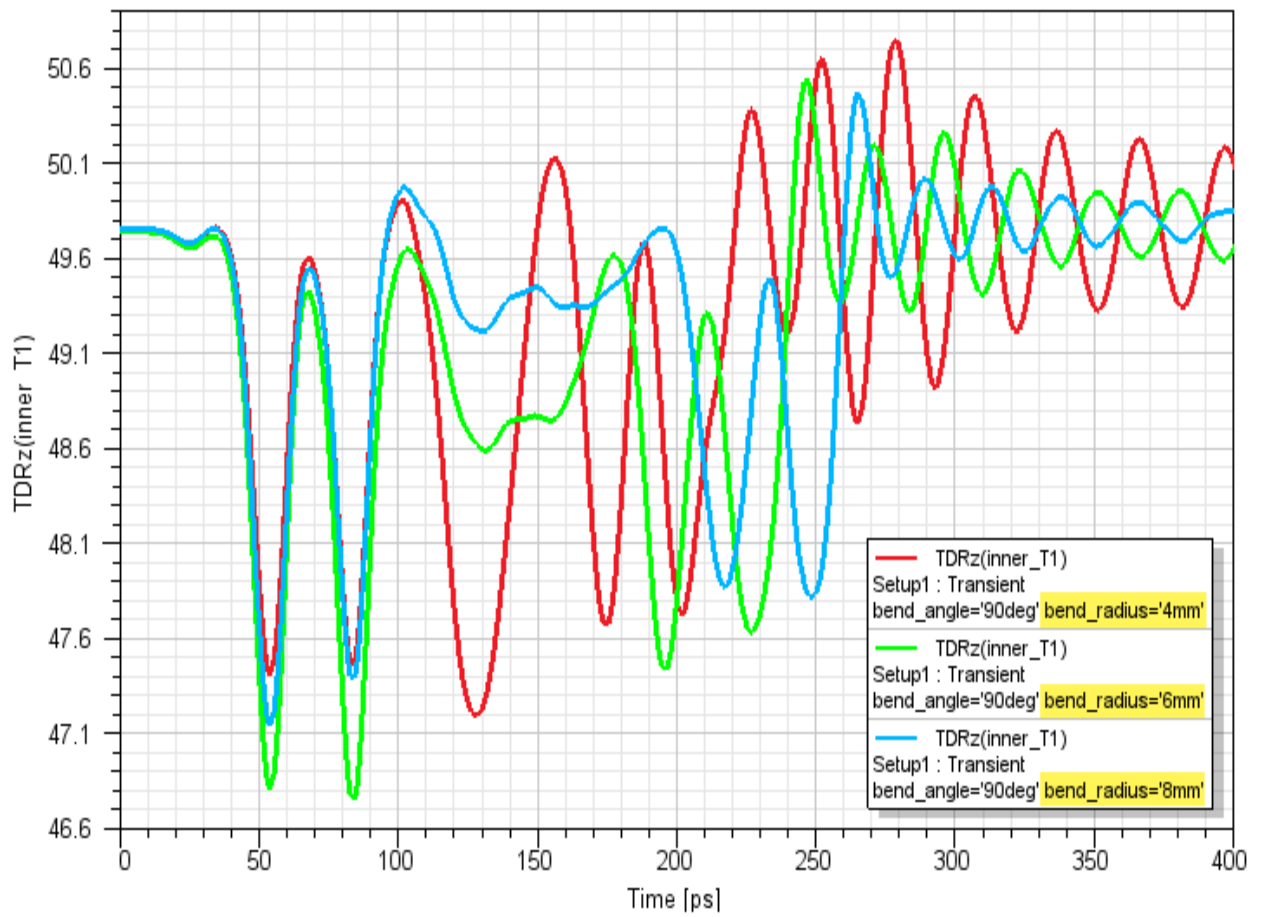

Figure 3-13: Effect of Bend Radius on TDR Impedance

Observations:

The area of interest is between 100 and 190 ps, which is when the field is passing through the bend (up to approximately 143, 165, and 185 ps, respectively, for the 4, 6, and 8 mm radii). You can observe the following effects:

- The larger the radius, the smaller the deviation from the 50 Ω characteristic impedance and the lesser the impedance fluctuations while the signal goes through the bend. However, disturbances due to the slugs are worse for the intermediate (6 mm) radius (green curve).
- The reflections from the second slug occur at a progressively later time as the radius is increased, due to the increasing travel distance around the bend.

15.  **Save** the project.

4 - Optionally, Restore Current View Orientations

You have completed this getting started guide.

If you prefer to use the new view orientations implemented in version 2024 R1 of the Ansys Electronics Desktop application, clear the *Use Legacy View Orientation* option as follows:

1. From the menu bar, click **View > Options**.

The *3D UI Options* dialog box appears.

2. Ensure that **Enable Legacy View Orientation** is cleared:

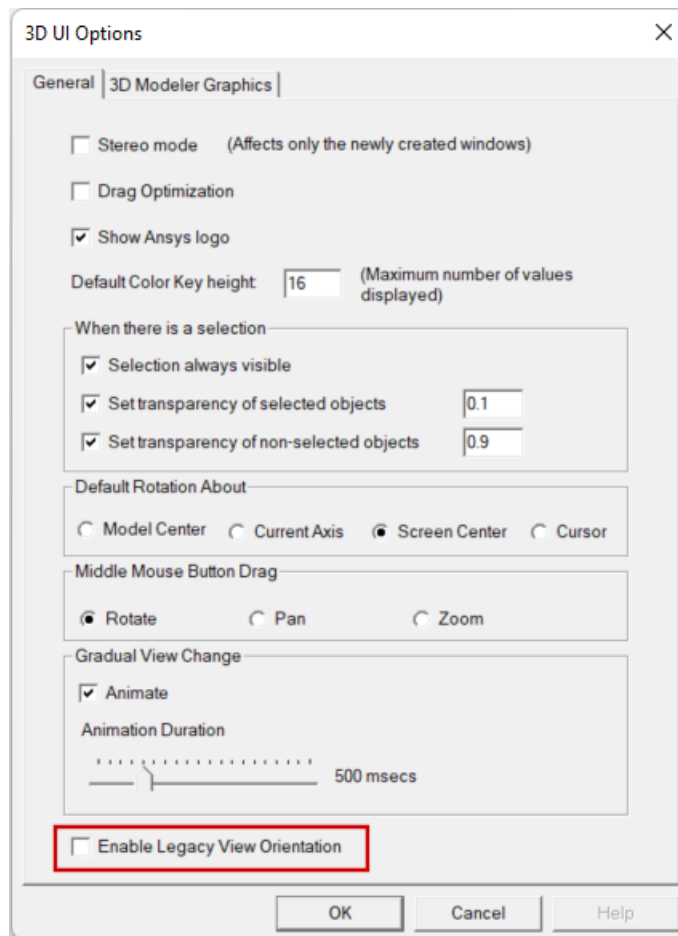

3. Click **OK**.

The settings in the 3D UI Options dialog box are global. Your choice is retained for all future program sessions, projects, and design types that use the 3D Modeler or that produce 3D plots of results.

You can now save and close this project.